

NOTE 1) 모터 21

No.	PART NAME	MATERIAL	Qt'y	SIZE	REMARK
01					

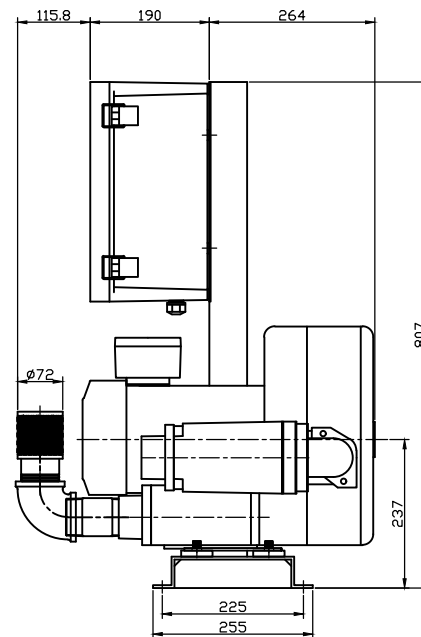
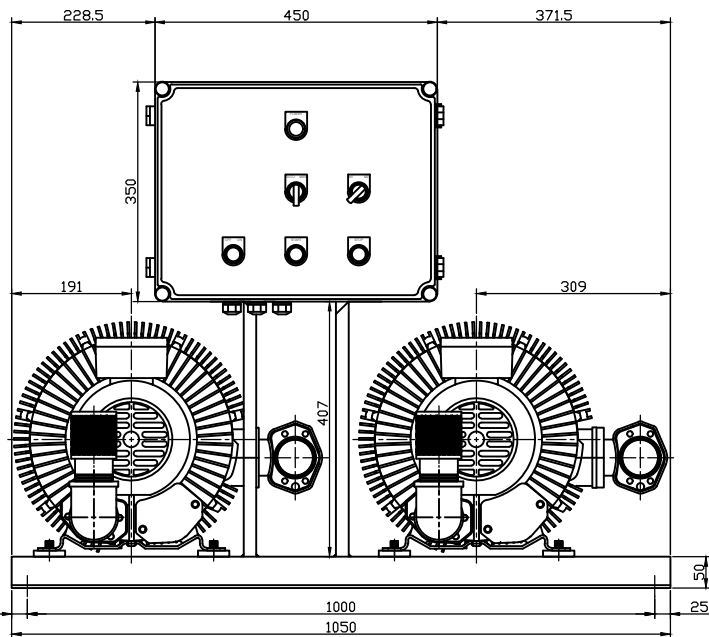
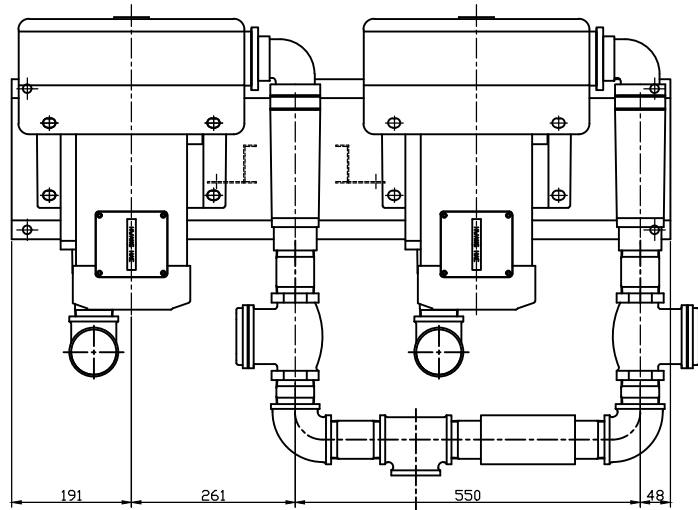

No.		Revision		Date	Draw	Check	Appr.
00							
형식 TYPE	HRB-702		도명 TITLE	외형도 (OUTWARD DWG.)			
DRAWN	DESIGN	CHECKED	APPROVED	3RD ANGLE	SCALE:1/1	UNIT:mm	
B.S.Kim						SIZE	3φ 2P 4.5kW
17.02.14						도번 DWG. No	BOD00438
黃海電機 HWANG HAE ELECTRIC							