

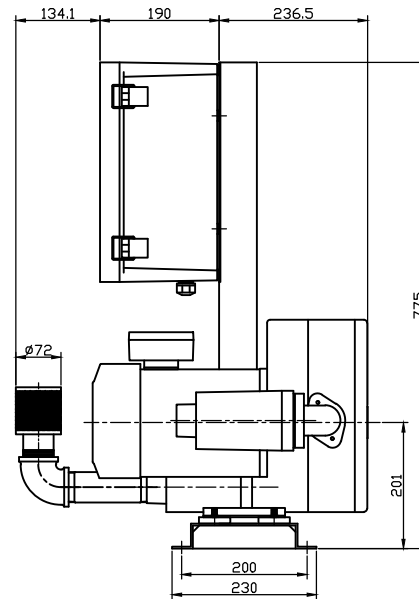

NOTE 1) 모터 21

No.	PART NAME	MATERIAL	Qt'y	SIZE	REMARK
01					

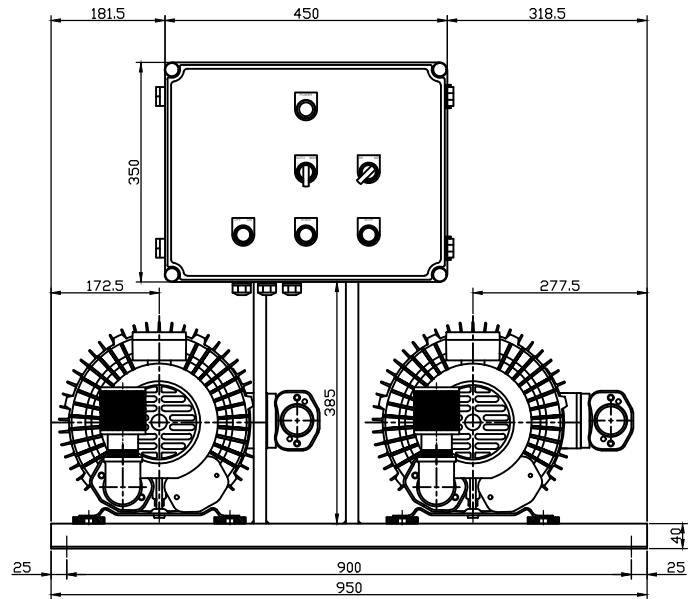
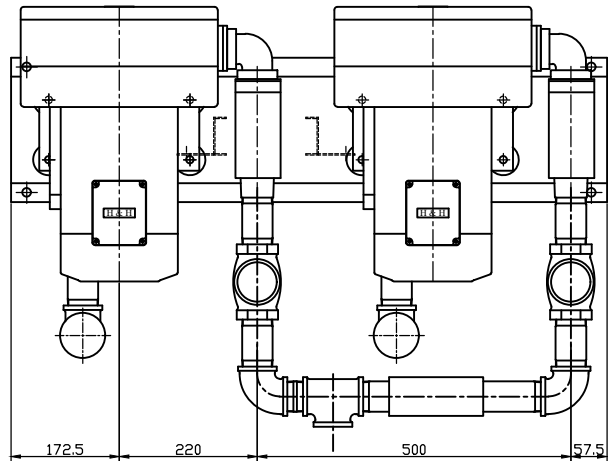

No.		Revision		Date	Draw	Check	Appr.
00							
형식 TYPE	HRB-402		도명 TITLE	외형도 (OUTWARD DWG.)			
DRAWN	DESIGN	CHECKED	APPROVED	3RD ANGLE	SCALE:1/1	UNIT:mm	
B.S.Kim				SIZE	3φ 2P 2.55kW		
17.02.01							
 黃海電機 HWANG HAE ELECTRIC				도번 DWG. No	BOD00435		